

## RACCORDI AUTOMATICI METALLICI CON GUARNIZIONI FKM

*METALLIC PUSH-IN FITTINGS WITH FKM SEAL*

*VOLLMETALL STECKVERSCHRAUBUNGEN MIT FKM DICHTUNGEN*

*RACCORDS INSTANTANÉS TOUT LAITON NICKELÉ JOINT FKM*

*RACORDAJE AUTOMÁTICO METÁLICO CON JUNTAS FKM*

*CONEXÕES PUSH-IN METÁLICAS COM VEDAÇÕES EM FKM*

Bar  30 Bar



# Serie 40000V

40000V

<b>New</b>									
	<b>40005V</b> Pag. 4.7	<b>40010V</b> Pag. 4.7	<b>40020V</b> Pag. 4.7	<b>40030V</b> Pag. 4.8	<b>40040V</b> Pag. 4.8	<b>40050V</b> Pag. 4.8	<b>40060V</b> Pag. 4.9	<b>40106V</b> Pag. 4.9	<b>40111V</b> Pag. 4.9
									
	<b>40116V</b> Pag. 4.10	<b>40126V</b> Pag. 4.10	<b>40130V</b> Pag. 4.10	<b>40216V</b> Pag. 4.11	<b>40226V</b> Pag. 4.11	<b>40230V</b> Pag. 4.11	<b>40310V</b> Pag. 4.12	<b>40550V</b> Pag. 4.12	<b>50600V</b> Pag. 4.12
									
	<b>CH028</b> Pag. 4.13	<b>50625</b> Pag. 4.13	<b>40700V</b> Pag. 4.13	<b>57610</b> Pag. 4.14	<b>50980</b> Pag. 4.14				

La serie 40000V, risponde alle esigenze del mercato dove si rende necessario un componente "High Performance". Un sistema di aggraffaggio del tubo altamente performante che consente di lavorare a pressioni elevate e sotto sforzo. Questa gamma deriva dallo sviluppo di applicazioni alta temperatura con PN 30 bar. Completamente in ottone nichelato, con tenute in FKM, in caso di presenza di vibrazioni, questa gamma garantisce la migliore tenuta, sia in pressione che con vuoto.

#### Principali vantaggi

- Utilizzabile con gas inerti e liquidi compatibili con i materiali costituenti
- Connessione e sconnessione istantanea
- Pieno passaggio e tenuta al vuoto grazie alle guarnizioni sagomate
- 3 tipologie di filettature, SHORT, BSPP e Metrica
- Alta Resistenza alle temperatura e pressione
- Silicon Free

#### Applicazioni

- Aria, acqua di raffreddamento, vuoto e vapore
- Automazione pneumatica in ambienti alta temperatura
- Automotive e Saldatura
- Industria Pesante, applicazioni gravose
- Presenza forti vibrazioni

The 40000V serie is considered an "High Performance" line in terms of pressure and temperature. Ideal for application with high temperature and pressure up to 30 bar.

Seals are FKM and clamping washers are double-performant to withstand to high pressure and traction.

Better sealing is guaranteed in case of strong vibrations and vacuum.

#### Main advantages

- Inert gases and Liquids compatible
- Quick connection and disconnection
- Full Flow and Vacuum resistant tank to special shaped seals
- 3 types of threads, SHORT, BSPP and Metric
- High resistance to temperature and pressure
- Silicon Free

#### Applications

- Compressed Air, Cooling Water, Vacuum, Steam
- Pneumatic automation with high temperature
- Automotive & Welding
- Heavy Duty Industry
- Vibrations environment

Die 40000V Serie ist eine "High Performance" Linie in Bezug auf Druck und Temperatur.

Ideal für Anwendungen mit hoher Temperatur und Druck bis zu 30 bar.

Die Dichtungen sind aus FKM und Spanscheiben sind doppelt-performant, um gegen hohen Druck und Zug zu bestehen.

Bessere Abdichtung bei starken Vibrationen und Vakuum wird garantiert.

#### Hauptvorteile

- Kompatibel für Inertgase und Flüssigkeiten
- Schnelle Verbindung und Trennung
- Voller Durchfluss und Vakuumfestigkeit, dank spezieller Formdichtungen
- 3 Gewindearten, SHORT, BSPP und metrisch
- Sehr temperatur- und druckbeständig
- Silikonfrei

#### Anwendungen

- Druckluft, Kühlwasser, Vakuum, Dampf
- Pneumatische Automation mit hohen Temperaturen
- Automobil-Industrie und Schweißen
- Schwerindustrie
- Umgebung mit Vibrationen

La série 40000V est considérée comme la gamme "Haute Performance" en termes de pression et de température. Idéale pour les températures élevées et une Pression Nominale de 30 bar maxi. En laiton nickelé avec joints FKM en standard, la série dispose d'un système de maintien à haute performance qui vous permet de travailler à des pressions élevées. En présence de vibrations, cette gamme assure également une parfaite étanchéité, sous pression et sous vide.

#### Principaux avantages

- Peut être utilisé avec des gaz inertes et liquides compatibles avec les matériaux
- Connexion et déconnexion instantanée
- Plein débit et tenue au vide grâce à des joints de forme
- 3 types de filetages, SHORT, BSPP et métrique
- Haute résistance à la température et pression
- Sans Silicone

#### Applications

- Air, eau de refroidissement, vide
- Automatisme pneumatique avec des températures élevées
- Automobile et soudage (ferrage)
- Industries lourdes
- Bonne tenue aux vibrations

La serie 40000V Aignep, responde a las exigencias del mercado donde se requiere un componente "High Performance" ya sea en términos de presión que de temperatura. Esta gama deriva del desarrollo de aplicaciones en alta temperatura con PN de 30 bar. Completamente en latón niquelado, con juntas de FKM de serie, la serie tiene un sistema de agarre del tubo de alto rendimiento que consiente trabajar en altas presiones y bajo esfuerzo. En caso de presencia de vibraciones, esta gama garantiza la mejor estanqueidad, ya sea en presión como en vacío.

#### Principales ventajas

- Utilizable con gases inertes y líquidos compatibles con el material constituyente
- Conexión y desconexión instantánea
- Paso total y estanqueidad al vacío gracias a las juntas moldeadas
- 3 tipos de rosca, CORTA, BSPP y Métrica
- Alta resistencia a la temperatura y presión
- Libre de silicona

#### Aplicaciones

- Aire, agua de refrigeración, vacío y vapor
- Automatización neumática en ambientes de alta temperatura
- Automoción y soldadura
- Industria pesada, aplicaciones gravosas
- Presencia de fuertes vibraciones

A série 40000V é considerada uma linha de "Alta Performance" em termos de pressão e temperatura. Ideal para aplicações com alta temperatura e pressões até 30 bar. As vedações são em FKM e as garras de travamento do tubo possuem alta performance tanto em altas pressões como em aplicações envolvendo tração. Vedações diferenciadas garantem performances mesmo em casos de fortes vibrações e vácuo.

#### Principais vantagens

- Gases inertes e líquidos compatíveis
- Rápida conexão e desconexão
- Vazão Total e resistência ao vácuo graças ao design de suas vedações
- 3 tipos de rosca, SHORT, BSPP e métrica
- Alta resistência a temperatura e pressão
- Livre de Silicone

#### Aplicações

- Ar Comprimido, Água de Resfriamento, Vácuo, Vapor
- Pneumática Automação com Alta Temperatura
- Automotiva & Solda
- Indústria Pesada
- Ambientes com Vibração



### CARATTERISTICHE TECNICHE

TECHNICAL CHARACTERISTICS  
TECHNISCHE ANGABEN  
CARACTÉRISTIQUES TECHNIQUES  
CARACTERÍSTICAS TÉCNICAS  
CARACTERÍSTICAS TÉCNICAS



### Norma di Riferimento

Reference standard

Entspricht der Norm

Norme de référence

Normativa de referencia

Norma de referência

1907/2006

REACH ✓

2011/65/CE

RoHS ✓

PED

2014/68/UE

ISO

14743:2020

SILICON

FREE

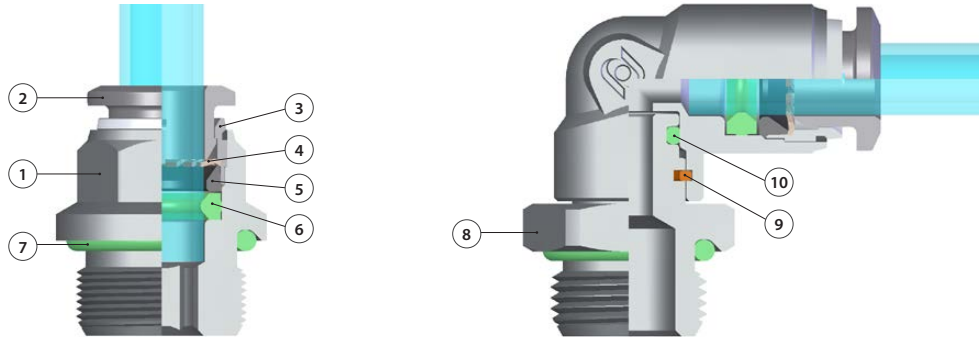

### Materiali e Componenti

- 1 Corpo in ottone nichelato
- 2 Spintore sgancio tubo in Ottone nichelato
- 3 Capsula in ottone nichelato
- 4 Pinza d'aggraffaggio in acciaio inox AISI 301
- 5 Anello di posizionamento in tecnopolimero
- 6 Guarnizione sagomata in FKM
- 7 Guarnizione filetto in FKM
- 8 Basetta Filettata in Ottone Nichelato
- 9 Seeger
- 10 Guarnizione in FKM

IT

### Component Parts and Materials

- 1 Nickel-plated brass Body
- 2 Nickel-plated brass Collet
- 3 Nickel-plated brass Capsule
- 4 Steel AISI 301 Clamping washer
- 5 Technopolymeric positioning ring
- 6 FKM Molded seal
- 7 FKM Thread packing
- 8 Base Threaded Nickel Plated Brass
- 9 Seeger
- 10 FKM seal

GB

### Komponenten und Materialien

- 1 Körper Messing vernickelt
- 2 Druckring Messing vernickelt
- 3 Haltering Messing vernickelt
- 4 Doppel-Zahnscheibe Edelstahl AISI 301
- 5 Positioniererring Technopolymer
- 6 Lippendichtung FKM
- 7 Gewindeabdichtung FKM
- 8 Gewindebasis Messing vernickelt
- 9 Seeger
- 10 O-Ringdichtung FKM

DE

### Matériaux et Composants

- 1 Corps: Laiton nickelé
- 2 Poussoir: Laiton nickelé
- 3 Capsule de retenue: Laiton nickelé
- 4 Rondelle d'accrochage: AISI 301
- 5 Anneau de positionnement: Technopolymère
- 6 Joint à lèvres: FKM
- 7 Joint d'étanchéité du filetage: FKM
- 8 Bague de sécurité en laiton nickelé
- 9 Seeger
- 10 Joint en FKM

FR

### Materiales y Componentes

- 1 Cuerpo en latón niquelado
- 2 Anillo de extracción tubo en latón niquelado
- 3 Cápsula en latón niquelado
- 4 Doble pinza de agarre en acero inox AISI 301
- 5 Anillo de posicionamiento en tecnopolimero
- 6 Junta de forma en FKM
- 7 Junta de la rosca en FKM
- 8 Base roscada en latón niquelado
- 9 Seeger
- 10 Junta tórica en FKM

ES

### Materiais e Componentes

- 1 Corpo em latão niquelado
- 2 Anilha de liberação em latão niquelado
- 3 Cápsula de latão niquelado
- 4 Pinça de travamento em aço-inox AISI 301
- 5 Anel de posicionamento em tecnopolimero
- 6 Vedação em FKM
- 7 Vedação da rosca em FKM
- 8 Base roscada em latão niquelado
- 9 Seeger
- 10 Vedação em FKM

PT



### Pressioni

Pressures

Druckbereich

Pressions

Presiones

Pressões

- 0.99 bar (-0.099 MPa)

30 bar (3.0 MPa)



### Temperature

Temperatures

Temperatur

Températures

Temperaturas

Temperaturas

- 15 °C

+ 130 °C



### Fluidi compatibili

Aria compressa / Vuoto / Acqua

Fluids

Compressed air / Vacuum / Water

Geeignete Medien

Druckluft / Vakuum / Wasser

Fluides compatibles

Air comprimé / Vide / Eau

Fluidos compatibles

Aire comprimido / Vacío / Agua

Fluidos compatíveis

Ar comprimido / Vácuo / Água



### Tubi di Collegamento

Tubi in materiale plastico:

PA6, PA11, PA12, Polietilene, \*Poliuretano, PTFE, FEP.

\*Utilizzo da 90 a 98 Shore, per la massima prestazione è consigliato 98 Shore A.

IT

### Connection Tubes

Plastic tubes:

PA6, PA11, PA12, Polyethylene, \*Polyurethane, PTFE, FEP.

\*Use from 90 to 98 Shore, for maximum performance is recommended 98 Shore A.

GB

### Geeignete Rohre

Kunststoffrohre:

PA6, PA11, PA 12, Polyethylene, \*Polyurethan, PTFE, FEP.

\*Verwenden Sie 90 bis 98 Shore, für maximale Leistung wird 98 Shore A empfohlen.

DE

### Tubes Conseillés

Tubes plastiques:

PA6, PA11, PA12, Polyéthylène, \*Polyuréthane, PTFE, FEP.

\*Utilisation de 90 à 98 Shore, pour une performance maximale recommandée 98 Shore A.

FR

### Tubos de Conexión

Tubos en material plástico:

PA6, PA11, PA 12, Polietileno, \*Poliuretano, PTFE, FEP.

\*Uso de 90 a 98 Shore, para un máximo rendimiento se recomienda 98 Shore A.

ES

### Tubos de Conexão

Tubos em material plástico:

PA6, PA11, PA12, Polietileno, \*Poliuretano, PTFE, FEP.

\*Uso de 90 a 98 Shore, para o desempenho máximo é recomendado 98 Shore A.

PT



<b>Filettatura</b>	<b>IT</b>	<b>Threads</b>	<b>GB</b>	<b>Gewindearten</b>	<b>DE</b>
Gas conica "UNIVERSAL SHORT". Gas cilindrica conforme ISO 228 Classe A. Metrica conforme ISO R/262.		"UNIVERSAL SHORT" Tapered thread. Parallel gas in conformity with ISO 228 Class A. Metric in conformity with ISO R/262.		Konisches Gewinde "UNIVERSAL SHORT". Zylindrisches Gewinde nach Norm ISO 228 Classe A. Metrisches Gewinde nach Norm ISO R/262.	
<b>Filetages</b>	<b>FR</b>	<b>Roscas</b>	<b>ES</b>	<b>Roscas</b>	<b>PT</b>
Filetage conique "UNIVERSAL SHORT". Filetage cylindrique conforme: ISO 228 Classe A. Filetage métrique conforme: ISO R/262.		Gas cónica "UNIVERSAL SHORT". Gas cilindrica conforme ISO 228 Classe A. Métrica conforme ISO R/262.		Gas cónica "UNIVERSAL SHORT". Gas paralela conforme ISO 228 Classe A. Métrica conforme ISO R/262.	



**UNIVERSAL SHORT**

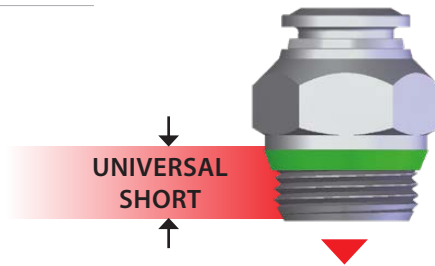

<b>NPT</b> <b>NPTF</b>	Conica Tapered Konisch Conique Cónica Cônica	<b>ISO 7</b> <b>BSPP</b>	Cilindrica Paralell Zylindrisch Cylindrique Cilíndrica Paralela	<b>ISO 7</b> <b>BSPT</b> <b>PT</b>	Conica Tapered Konisch Conique Cónica Cônica	<b>ISO 228</b> <b>BSP</b> <b>PF</b>	Cilindrica Paralell Zylindrisch Cylindrique Cilíndrica Paralela
---------------------------	---	-----------------------------	--	--	---	---	--

<b>"UNIVERSAL SHORT"</b>	<b>IT</b>	<b>"UNIVERSAL SHORT"</b>	<b>GB</b>	<b>"UNIVERSAL SHORT"</b>	<b>DE</b>
La filettatura conica "UNIVERSAL SHORT" è progettata per soddisfare le seguenti caratteristiche: • ridurre la lunghezza d'ingombro; • ridurre la chiave rispetto ad alcuni raccordi con filettature cilindriche; • consentire l'accoppiamento con diversi standard di filettature femmina sia coniche che cilindriche.		The "UNIVERSAL SHORT" taper thread has been designed to offer the following advantages to the users: • reduced overall length; • smaller hex dimensions compared to the parallel threads; • to allow the assembly with different female threads both taper as well as parallel.		Das konische Gewinde "UNIVERSAL SHORT" ist so konzipiert, dass folgende Vorteile erzielt werden: • Reduzierung der Länge des Gewindes-kürzere Montagezeit; • Reduzierung der Schlüsselweite im Vergleich von Verschraubungen mit zylindrischen Gewinden-geringer Lochabstand; • Ermöglicht den Einsatz in verschiedene Gewindearten, sowie in konische- und zylindrische Innengewinde.	

<b>"UNIVERSAL SHORT"</b>	<b>FR</b>	<b>"UNIVERSAL SHORT"</b>	<b>ES</b>	<b>"UNIVERSAL SHORT"</b>	<b>PT</b>
Le filetage conique "UNIVERSAL SHORT" a été conçu pour satisfaire les exigences suivantes: • réduire la longueur d'encombrement; • réduire les dimensions hexagonales par rapport au filetage cylindrique; • permettre le montage avec divers taraudages standards soit coniques soit cylindriques.		La rosca cónica "UNIVERSAL SHORT" ha sido proyectada para satisfacer las siguientes características: • reducir la longitud; • reducir la llave respecto a algunos racores con rosca cilíndrica; • consentir el acoplamiento con diferentes standard de rosca hembra sean cónicas o cilíndricas.		A rosca cónica "UNIVERSAL SHORT" é projetada para satisfazer às seguintes características: • reduzir o comprimento da conexão; • reduzir o dimensional com relação às rosca paralelas; • permitir o acoplamento da conexão a diferentes tipos de rosca fêmea, sejam elas cónicas ou paralelas.	

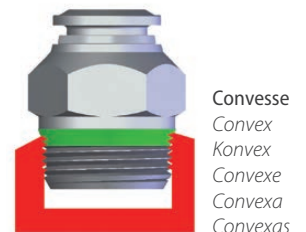
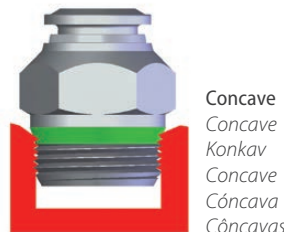
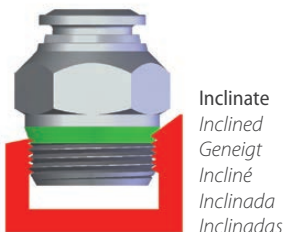

<b>Consentire una completa tenuta anche su superfici non perfettamente piane, concave, convesse o inclinate, con diversi smussi o raggi.</b>	<b>IT</b>	<b>To ensure the right tightening also with surfaces not perfectly flat, without spot-facing, concave convex and with different kinds of chamfers or radius.</b>	<b>GB</b>	<b>Eine vollständige Abdichtung ist auch auf unebenen Flächen, wie geneigt, konkav oder konvex und mit unterschiedlichen Radien oder Fasen gewährleistet.</b>	<b>DE</b>
--	-----------	--	-----------	---	-----------

<b>Pour permettre une parfaite étanchéité même sur des surfaces non planes, concaves, convexas ou inclinées et avec différents chanfreins ou rayons.</b>	<b>FR</b>	<b>Consentir una completa estanqueidad incluso en superficies no perfectamente planas, cóncavas, convexas o inclinadas, con diferentes ángulos o radios.</b>	<b>ES</b>	<b>Permite um aperto correto em superfícies não perfeitamente planas, côncavas, convexas ou inclinadas, com diferentes chanfros ou raios.</b>	<b>PT</b>
--	-----------	--	-----------	---	-----------



### Coppia di serraggio

Torque specifications

Angaben Drehmoment

Couple de serrage

Par de apriete

Especificações de Torque

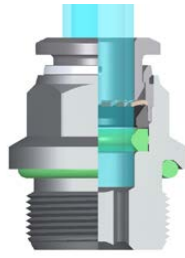

ISO 228

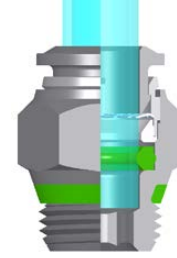

"UNIVERSAL SHORT"

I valori di rottura possono variare in base all'articolo  
 Breaking values may vary according to the item  
 Die maximal werte dienen nur zu Informationszwecken  
 Les valeurs maximales sont présentées à titre indicatif  
 Los valores de rotura pueden variar en función del artículo  
 Os valores de ruptura podem variar em função do item

MISURA MEASURE GRÖSSE DIMENSIONS MEDIDA MEDIDA	COPPIA CONSIGLIATA Nm RECOMMENDED TORQUE Nm EMPFOHLENES DREHMOMENT Nm COUPLE DE SERRAGE Nm PAR ACONSEJADO Nm TORQUE RECOMENDADO Nm	COPPIA DI ROTTURA Nm BREAKING TORQUE Nm ABSCHERDREHMOMENT Nm COUPLE DE RUPTURE Nm PAR DE ROTURA Nm TORQUE DE RUPTURA Nm
M5	0,8	3,2
M7	3	8
M8	3	8
1/8	3	8
1/4	9	30
3/8	10	60
1/2	12	50

MISURA MEASURE GRÖSSE DIMENSIONS MEDIDA MEDIDA	COPPIA MINIMA CONSIGLIATA Nm RECOMMENDED MINIMUM TORQUE Nm EMPFOHLENES DREHMOMENT Nm COUPLE DE SERRAGE Nm PAR MÍNIMO ACONSEJADO Nm TORQUE MÍNIMO RECOMENDADO Nm	COPPIA MASSIMA CONSIGLIATA Nm RECOMMENDED MAX TORQUE Nm ABSCHERDREHMOMENT Nm COUPLE DE RUPTURE Nm PAR MÁXIMO ACONSEJADO Nm TORQUE MÁXIMA RECOMENDADO Nm
1/8	5	7
1/4	5	7
3/8	5	7
1/2	5	7

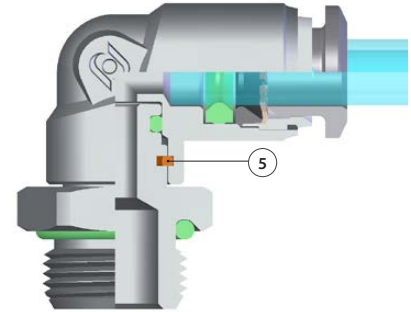
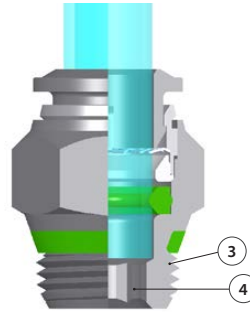
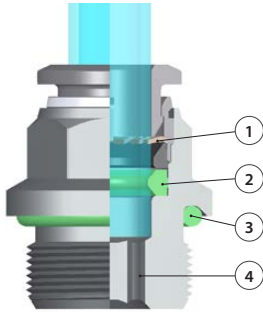

### Vantaggi

- 1 La pinza in acciaio inox garantisce il perfetto aggraffaggio di tubi di qualsiasi materiale senza danneggiarne la superficie. Il collegamento tra tubo e raccordo assicura una tenuta totale anche in condizioni di urti e vibrazioni.
- 2 La particolare geometria della guarnizione permette inoltre l'utilizzo dei raccordi anche con il vuoto.
- 3 Tutte le filettature di questa serie sono state dotate di elementi di tenuta che permettono l'immediato utilizzo dei raccordi riducendo notevolmente i tempi di installazione.
- 4 Tutti i raccordi diritti possono essere montati anche con chiave esagonale ed è possibile utilizzarli anche in spazi molto ridotti.
- 5 Raccordo orientabile con anello di sicurezza interno. Garantisce maggiore durata alla rotazione e trazione.

IT

### Advantages

- 1 The washer is made in stainless steel ensures the perfect tube clamping with every kinds of materials without damage the surface. The connection between the tube and the fitting ensure a total tightness even in severe conditions such as impact and vibrations.
- 2 The particular geometric shape of the seal ensure the perfect tightness even with vacuum.
- 3 All of threads from this range have been equipped with tightening parts which allow the direct assembly of the fittings, reducing the installation time.
- 4 All the straight fittings can be assembled also with Allen wrench and it is possible to use them in reduced spaces.
- 5 Orienting fitting with safety ring inside. Improved durability to the rotation and traction.

GB

### Vorteile

- 1 Konisches Gewinde "kurz" Die Zahnscheibe sorgt für eine perfekte Halterung des Rohres ohne die Oberfläche zu beschädigen. Die Dichtheit zwischen Rohr und Verschraubung ist auch bei Erschütterungen und Vibrationen gewährleistet.
- 2 Die besondere Geometrie der Dichtung ermöglicht auch die Anwendung der Verschraubungen in Verbindung mit Vakuum.
- 3 Alle Verschraubungen in dieser Serie sind mit Gewindeabdichtungen ausgestattet, die den sofortigen Einsatz ermöglichen und daher die Montagezeit stark reduzieren.
- 4 Alle geraden Verschraubungen können auch mit Inbusschlüsseln montiert werden, daher kleiner Lochabstand möglich.
- 5 Flexible Montage mit Sicherungsring innen. Verbesserte Beständigkeit gegenüber der Drehung und Traktions.

DE

### Avantages

- 1 La rondelle en acier inoxydable garantit la parfaite tenue du tube quelle que soit la matière et sans l'endommager. La connexion entre le tube et le raccord assure une étanchéité totale même dans des conditions d'impact ou de vibrations.
- 2 La spécificité géométrique du joint permet l'utilisation des raccords avec le vide.
- 3 Tous les filetages de cette série sont équipés d'éléments d'étanchéité qui permettent l'utilisation immédiate des raccords réduisant ainsi le temps d'installation.
- 4 Tous les raccords droits peuvent être aussi montés avec une clé hexagonale pour permettre une utilisation dans des espaces réduits.
- 5 Accessoire de fixation réglable avec anneau de sécurité à l'intérieur. Amélioration de la durée de la rotation et de traction.

FR

### Ventajas

- 1 La pinza en acero inoxidable garantiza el perfecto agarre del tubo de cualquier material sin perjudicar la superficie. La conexión entre tubo y racor asegura una estanqueidad total aun en condiciones de impacto o vibración.
- 2 La particular geometría de la junta garantiza una perfecta estanqueidad incluso en vacío.
- 3 Todas las rosas de esta serie están fabricadas con junta de cierre que permite la inmediata utilización del racor reduciendo notablemente el tiempo de instalación.
- 4 Todos los racores rectos pueden montarse también con llave hexagonal y es posible utilizarlos incluso en espacios muy reducidos.
- 5 Montaje ajustable con sistema de seguridad interior. La mejora de la durabilidad a la rotación y tracción.

ES

### Vantagens

- 1 A pinça em aço-inox garante o perfeito travamento do tubo de qualquer material sem danificar a superfície do mesmo. A conexão entre o tubo e a conexão assegura uma vedação total também em condições de impactos e vibrações.
- 2 A geometria particular da vedação permite a utilização da conexão também para aplicações com vácuo.
- 3 Todas as rosas desta série são dotadas de elementos de vedação, o que permite a imediata utilização das conexões, reduzindo notavelmente o tempo de instalação.
- 4 Todas as conexões retas podem ser montadas também com chave allenando possível montagem das mesmas em espaços bem reduzidos.
- 5 Montagem ajustável com anel de segurança dentro. A durabilidade melhorada para a rotação e tração.

PT

## 40005V

**New**

### RACCORDO DIRITTO MASCHIO "UNIVERSAL SHORT"

STRAIGHT MALE ADAPTOR "UNIVERSAL SHORT"  
 GERADE EINSCHRAUBVERSCHRAUBUNG KONISCH "UNIVERSAL SHORT"  
 RACCORD DROIT MÂLE, CONIQUE "UNIVERSAL SHORT"  
 RACOR RECTO MACHO CÓNICO "UNIVERSAL SHORT"  
 CONEXÃO RETA COM ROSCA "UNIVERSAL SHORT"

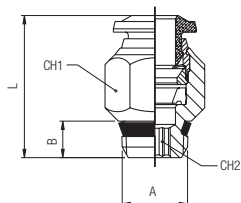

Code	Tube	A	B	L	CH1	CH2	Pack.
40005 V0 002	6	1/8	5.5	21.5	13	4	10
40005 V0 004	8	1/8	5.5	24.5	14	5	10
40005 V0 005	8	1/4	7	22	14	6	10
40005 V0 006	8	3/8	7.5	22.5	17	6	10
40005 V0 007	10	1/4	7	28	17	7	10
40005 V0 017	10	1/2	9	26	21	8	10
40005 V0 009	12	1/4	7	31.5	20	7	10
40005 V0 010	12	3/8	7.5	29.5	20	9	10

## 40010V

### RACCORDO DIRITTO MASCHIO CILINDRICO ESAGONO INCASSATO

STRAIGHT MALE ADAPTOR (PARALLEL) WITH HEXAGON EMBEDDED  
 GERADE EINSCHRAUBVERSCHRAUBUNG MIT INNENSECHSKANT ZYLINDRISCH  
 RACCORD DROIT MÂLE, CYLINDRIQUE, 6-PANS INTERIEUR  
 RACOR RECTO MACHO CILÍNDRICO HEXÁGONO INTERIOR  
 CONEXÃO RETA COM SEXTAVADO INTERNO E ROSCA MÉTRICA

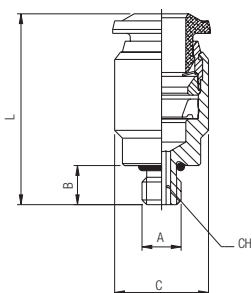

Code	Tube	A	B	C	L	CH	Pack.
40010 V0 001	4	M5	3.6	10	21	2.5	10
40010 V0 007	6	M5	3.6	12	24.5	2.5	10

## 40020V

### RACCORDO DIRITTO MASCHIO CILINDRICO

STRAIGHT MALE ADAPTOR (PARALLEL)  
 GERADE EINSCHRAUBVERSCHRAUBUNG ZYLINDRISCH  
 RACCORD DROIT MÂLE, CYLINDRIQUE  
 RACOR RECTO MACHO CILÍNDRICO CON TÓRICA  
 CONEXÃO RETA COM ROSCA PARALELA

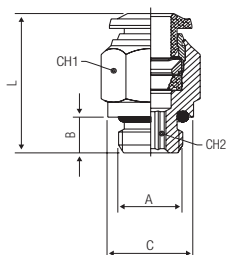

Code	Tube	A	B	C	L	CH1	CH2	Pack.
40020 V0 001	4	M5	3.6	8	20	10	2	10
40020 V0 037	4	M6X1	3.6	10	20	10	2.5	10
40020 V0 033	4	M8X1	5.4	12	18.5	10	3	10
40020 V0 002	4	1/8	5.4	13	20	10	3	10
40020 V0 022	4	1/4	7.1	16	19.5	16	3	10
40020 V0 020	6	M5	3.6	10	26.5	13	2	10
40020 V0 003	6	1/8	5.4	13	23.5	13	4	10
40020 V0 004	6	1/4	7.1	16	23.5	13	4	10
40020 V0 027	6	3/8	8.1	20	25	13	4	10
40020 V0 028	6	1/2	9.6	25	27	13	4	10
40020 V0 005	8	1/8	5.4	13	25	14	5	10
40020 V0 006	8	1/4	7.1	16	23	14	6	10
40020 V0 007	8	3/8	8.1	20	24	14	6	10
40020 V0 029	8	1/2	9.6	25	26.5	14	6	10
40020 V0 008	10	1/4	7.1	16	30.5	17	6	10
40020 V0 009	10	3/8	8.1	20	27.5	17	8	10
40020 V0 031	10	1/2	9.6	25	27	17	8	10
40020 V0 032	12	1/4	7.1	16	34.5	20	6	10
40020 V0 011	12	3/8	8.1	20	34	20	8	10
40020 V0 023	12	1/2	9.6	25	31	22	10	10
40020 V0 024	14	3/8	8.1	20	35	21	10	10
40020 V0 025	14	1/2	9.6	25	32	22	11	10

## 40030V

### RACCORDO DIRITTO FEMMINA

STRAIGHT FEMALE ADAPTOR  
 AUFSCHRAUBVERSCHRAUBUNG  
 RACCORD DROIT, TARAUDE  
 RACOR RECTO HEMBRA  
 CONEXÃO RETA COM ROSCA FÊMEA

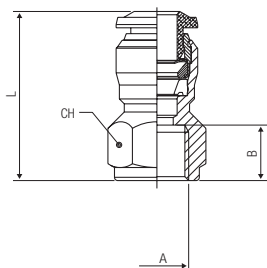

Code	Tube	A	B	L	CH	Pack.
40030 V0 008	4	M5	5.5	21	11	10
40030 V0 001	4	1/8	8.5	24	13	10
40030 V0 009	4	1/4	11	27.5	16	10
40030 V0 002	6	1/8	8.5	26	13	10
40030 V0 007	6	1/4	11	29.5	16	10
40030 V0 004	8	1/8	8.5	27	15	10
40030 V0 005	8	1/4	11	29.5	17	10
40030 V0 010	8	3/8	12	32	19	10
40030 V0 011	10	1/4	11	32	18	10
40030 V0 012	10	3/8	12	33.5	19	10
40030 V0 013	10	1/2	15	39	24	10
40030 V0 014	12	3/8	12	36	21	10
40030 V0 015	12	1/2	15	41	24	10

## 40040V

### RACCORDO DIRITTO INTERMEDIO

STRAIGHT CONNECTOR  
 VERBINDUNGSVERSCHRAUBUNG  
 RACCORD UNION DOUBLE  
 RACOR RECTO INTERMEDIO  
 CONEXÃO RETA TUBO-TUBO

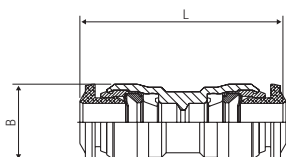

Code	Tube	Tube	L	B	Pack.
40040 V0 001	4 (5/32)	4 (5/32)	30.5	10.5	10
40040 V0 002	6	4	32	12.5	10
40040 V0 003	6	6	34	12.5	10
40040 V0 004	8	6	35	14.5	10
40040 V0 005	8 (5/16)	8 (5/16)	36	14.5	10
40040 V0 011	10	8	40.5	17.5	10
40040 V0 006	10	10	42	17.5	10
40040 V0 012	12	10	45.5	20.5	10
40040 V0 007	12	12	47	20.5	10
40040 V0 010	14	14	49	21.5	10

## 40050V

### RACCORDO DIRITTO INTERMEDIO DI ATTRAVERSAMENTO

BULKHEAD CONNECTOR  
 SCHOTTVERSCHRAUBUNG  
 RACCORD TRAVERSÉE DE CLOISON  
 RACOR RECTO INTERMEDIO PASATABIQUES  
 CONEXÃO PASSA-MURO RETA TUBO-TUBO

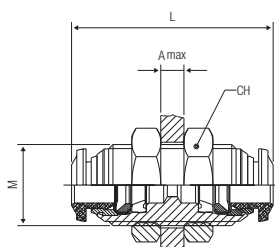

Code	Tube	M	L	CH	Amax	Pack.
40050 V0 001	4 (5/32)	M12x1	31.5	17	7	10
40050 V0 002	6	M14x1	35	17	9.5	10
40050 V0 009	8(5/16)-6	M16x1	37	19	10.5	10
40050 V0 003	8(5/16)	M16x1	37	19	10.5	10
40050 V0 010	10-6	M20x1	43	24	11.5	10
40050 V0 011	10-8	M20x1	43	24	12.5	10
40050 V0 004	10	M20x1	43	24	12.5	10
40050 V0 005	12	M22x1	48	26	16.5	10

## 40060V

### RACCORDO A L ORIENTABILE INTERMEDIO DI ATTRAVERSAMENTO

BULKHEAD ORIENTING ELBOW

WINKEL-SCHOTTVERSCHRAUBUNG (DREHBAR)

RACCORD EQUERRE ORIENTABLE A TRAVERSEE DE CLOISON

RACOR A L ORIENTABLE INTERMEDIO PASATABIQUES

CONEXÃO PASSA-MURO EM "L" ORIENTÁVEL

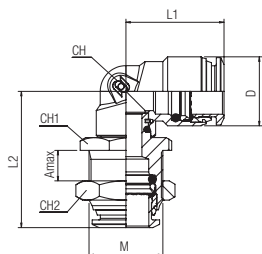

Code	Tube	M	L1	L2	D	CH	CH1	CH2	A <sub>max</sub>	Pack.
40060 V0 003	4	M12x1	17.5	26	10	9	14	17	6	10
40060 V0 004	6	M14x1	21.5	31	12.5	11	16	17	6.5	10
40060 V0 005	8	M16x1	22	34	14.5	12	18	19	6.5	10
40060 V0 006	10	M20x1	26.5	36	17.5	14	22	24	7.5	10
40060 V0 007	12	M22x1	30.5	43	21.5	16	24	26	9	10
40060 V0 008	14	M23x1	30.5	43	21.5	16	25	27	9.5	10

## 40106V

### RACCORDO A L ORIENTABILE FEMMINA

ORIENTING ELBOW FEMALE ADAPTOR

AUFSCRAUB-WINKELSCHRAUBUNG (DREHBAR)

RACCORD EQUERRE ORIENTABLE TARAUDE

RACOR A L ORIENTABLE HEMBRA

CONEXÃO EM "L" ORIENTÁVEL COM ROSCA FÊMEA

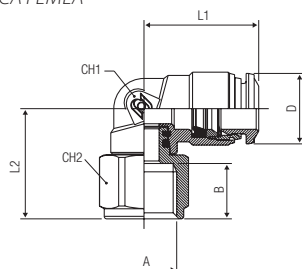

Code	Tube	A	B	L1	L2	CH1	CH2	D	Pack.
40106 V0 001	4	1/8	8.5	18	20	9	13	10	10
40106 V0 002	4	1/4	11	18	21.5	9	16	10	10
40106 V0 003	6	1/8	8.5	21	20.5	11	13	12.5	10
40106 V0 004	6	1/4	11	21	23	11	16	12.5	10
40106 V0 005	8	1/8	8.5	22.5	20.5	12	13	14.5	10
40106 V0 006	8	1/4	11	22.5	23	12	16	14.5	10

## 40111V

### RACCORDO A L ORIENTABILE MASCHIO "UNIVERSAL SHORT"

ORIENTING ELBOW MALE ADAPTOR "UNIVERSAL SHORT"

WINKELVERSCHRAUBUNG KONISCH (DREHBAR) "UNIVERSAL SHORT"

EQUERRE ORIENTABLE MÂLE, CONIQUE "UNIVERSAL SHORT"

RACOR A L ORIENTABLE MACHO "UNIVERSAL SHORT"

CONEXÃO MACHO EM "L" ORIENTÁVEL COM ROSCA "UNIVERSAL SHORT"

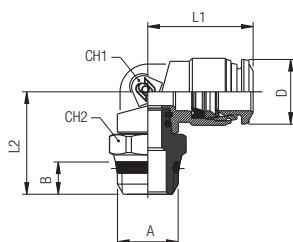

Code	Tube	A	B	L1	L2	CH1	CH2	D	Pack.
40111 V0 003	4	1/8	5.5	18	19.5	9	13	10	10
40111 V0 002	4	1/4	7	18	21	9	15	10	10
40111 V0 004	6	1/8	5.5	21	21.5	11	13	12.5	10
40111 V0 005	6	1/4	7	21	23	11	15	12.5	10
40111 V0 006	8	1/8	5.5	22.5	22.5	12	13	14.5	10
40111 V0 007	8	1/4	7	22.5	22.5	12	15	14.5	10
40111 V0 008	8	3/8	7.5	22.5	23	12	17	14.5	10
40111 V0 009	8	1/2	9	22.5	25.5	12	21	14.5	10
40111 V0 010	10	1/4	7	26.5	28.5	14	16	17.5	10
40111 V0 011	10	3/8	7.5	26.5	28	14	17	17.5	10
40111 V0 012	10	1/2	9	26.5	29	14	21	17.5	10
40111 V0 013	12	3/8	7.5	31.5	27.2	16	20	21.5	10
40111 V0 014	12	1/2	9	31.5	29.7	16	21	21.5	10
40111 V0 015	14	3/8	7.5	31.5	28.2	16	20	21.5	10
40111 V0 016	14	1/2	9	31.5	30.7	16	21	21.5	10

## 40116V

### RACCORDO A L ORIENTABILE MASCHIO CILINDRICO

ORIENTING ELBOW MALE ADAPTOR (PARALLEL)

WINKELVERSCHRAUBUNG ZYLINDRISCH (DREHBAR)

EQUERRE ORIENTABLE MÂLE, CYLINDRIQUE

RACOR A L ORIENTABLE MACHO CILÍNDRICO CON TÓRICA

CONEXÃO MACHO EM "L" ORIENTÁVEL COM ROSCA PARALELA

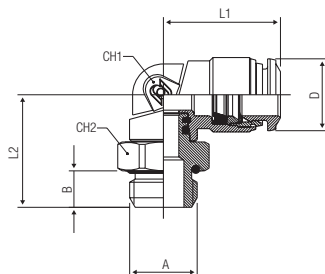

Code	Tube	A	B	L1	L2	CH1	CH2	D	Pack.
40116 V0 002	4	M5	3.6	17.5	18	9	8	10	10
40116 V0 026	4	M6X1	3.6	17.5	18	9	8	10	10
40116 V0 027	4	M8X1	5.4	17.5	18	9	12	10	10
40116 V0 003	4	1/8	5.4	18	18	9	13	10	10
40116 V0 004	4	1/4	7.1	18	18	9	16	10	10
40116 V0 007	6	M5	3.6	21	20	11	11	12.5	10
40116 V0 028	6	M10X1	5.4	21	20	11	13	12.5	10
40116 V0 008	6	1/8	5.4	21	20	11	13	12.5	10
40116 V0 009	6	1/4	7.1	21	21.5	11	16	12.5	10
40116 V0 010	8	1/8	5.4	22.5	21	12	13	14.5	10
40116 V0 011	8	1/4	7.1	22.5	21.5	12	16	14.5	10
40116 V0 012	8	3/8	8.1	22.5	23.5	12	20	14.5	10
40116 V0 013	8	1/2	9.6	22.5	25	12	25	14.5	10
40116 V0 014	10	1/4	7.1	26.5	27.5	14	16	17.5	10
40116 V0 015	10	3/8	8.1	26.5	27	14	20	17.5	10
40116 V0 016	10	1/2	9.6	26.5	28.5	14	25	17.5	10
40116 V0 025	12	1/4	7.1	31.5	27.8	16	20	21.5	10
40116 V0 017	12	3/8	8.1	30.5	27.3	16	20	21.5	10
40116 V0 018	12	1/2	9.6	30.5	28.8	16	25	21.5	10
40116 V0 019	14	3/8	8.1	30.5	28.3	19	20	21.5	10
40116 V0 020	14	1/2	9.6	30.5	29.8	19	25	21.5	10

## 40126V

### RACCORDO A L ORIENTABILE PROLUNGATO MASCHIO CILINDRICO

EXTENDED ORIENTING ELBOW MALE ADAPTOR (PARALLEL)

VERLÄNGERTE WINKELVERSCHRAUBUNG ZYLINDRISCH (DREHBAR)

EQUERRE PROLONGÉE ORIENTABLE MÂLE, CYLINDRIQUE

RACOR A L ORIENTABLE PROLONGADO MACHO CILÍNDRICO CON TÓRICA

CONEXÃO MACHO EM "L" PROLONGADO COM ROSCA PARALELA

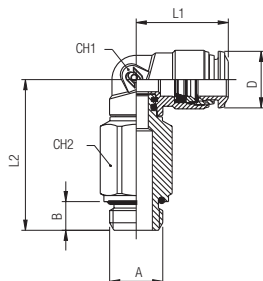

Code	Tube	A	B	L1	L2	CH1	CH2	D	Pack.
40126 V0 004	6	1/8	5.4	21	34.5	11	12	12.5	10
40126 V0 006	8	1/8	5.4	22.8	37.5	12	12	14.5	10
40126 V0 007	8	1/4	7.1	22.5	38	12	15	14.5	10
40126 V0 009	10	1/4	7.1	26.5	46.6	14	16	17.5	10

## 40130V

### RACCORDO A L INTERMEDIO

ELBOW CONNECTOR

WINKELVERSCHRAUBUNG

RACCORD EQUERRE

RACOR A L INTERMEDIO

CONEXÃO EM "L" TUBO-TUBO

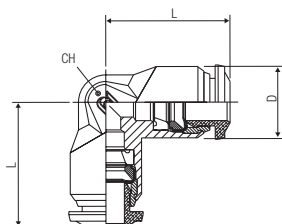

Code	Tube	L	CH	D	Pack.
40130 V0 001	4 (5/32)	17	9	10	10
40130 V0 002	6	21	11	12.5	10
40130 V0 003	8 (5/16)	22.5	13	14	10
40130 V0 004	10	26.5	16	17	10
40130 V0 005	12	30.5	19	21.5	10
40130 V0 008	14	32.5	19	21.5	10

## 40216V

### RACCORDO A T ORIENTABILE MASCHIO CILINDRICO

ORIENTING TEE MALE ADAPTOR (PARALLEL) CENTRE LEG  
 T-EINSCHRAUBVERSCHRAUBUNG ZYLINDRISCH (DREHBAR)  
 TÉ ORIENTABLE À PIQUAGE MÂLE CENTRAL, CYLINDRIQUE  
 RACOR A T ORIENTABLE MACHO CENTRAL CILÍNDRICO CON TÓRICA  
 CONEXÃO MACHO EM "T" ORIENTÁVEL COM ROSCA PARALELA

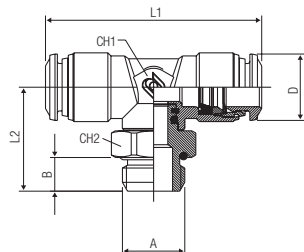

Code	Tube	A	B	L1	L2	CH1	CH2	D	Pack.
40216 V0 002	4	M5	3.6	34	18	9	8	10	10
40216 V0 003	4	1/8	5.4	34	18.5	9	13	10	10
40216 V0 004	4	1/4	7.1	34	20	9	16	10	10
40216 V0 007	6	M5	3.6	42	20.5	11	11	12.5	10
40216 V0 008	6	1/8	5.4	42	20.5	11	13	12.5	10
40216 V0 009	6	1/4	7.1	42	22	11	16	12.5	10
40216 V0 010	8	1/8	5.4	45	23.5	13	13	14.5	10
40216 V0 011	8	1/4	7.1	45	24	13	16	14.5	10
40216 V0 012	8	3/8	8.1	45	26	13	20	14.5	10
40216 V0 013	8	1/2	9.6	45	27.5	13	25	14.5	10
40216 V0 014	10	1/4	7.1	53	27.1	14	16	17.5	10
40216 V0 015	10	3/8	8.1	53	26.6	14	20	17.5	10
40216 V0 016	10	1/2	9.6	53	28.1	14	25	17.5	10
40216 V0 017	12	3/8	8.1	62.5	29.1	16	20	21.5	10
40216 V0 018	12	1/2	9.6	62.5	31.6	16	25	21.5	10
40216 V0 019	14	3/8	8.1	62.5	29.1	16	20	21.5	10
40216 V0 020	14	1/2	9.6	62.5	31.6	16	25	21.5	10

## 40226V

### RACCORDO A T ORIENTABILE MASCHIO LATERALE CILINDRICO

ORIENTING TEE MALE ADAPTOR (PARALLEL) OFF - SET LEG  
 L-EINSCHRAUBVERSCHRAUBUNG ZYLINDRISCH (DREHBAR)  
 TÉ ORIENTABLE À PIQUAGE LATÉRAL, CYLINDRIQUE  
 RACOR A T ORIENTABLE MACHO LATERAL CILÍNDRICO CON TÓRICA  
 CONEXÃO MACHO EM "T" LATERAL ORIENTÁVEL COM ROSCA PARALELA

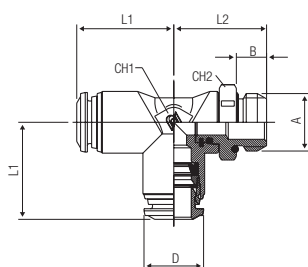

Code	Tube	A	B	L1	L2	CH1	CH2	D	Pack.
40226 V0 002	4	M5	3.6	17	18	9	8	10	10
40226 V0 003	4	1/8	5.4	17	18.5	9	13	10	10
40226 V0 004	4	1/4	7.1	17	20	9	16	10	10
40226 V0 007	6	M5	3.6	21	20.5	11	11	12.5	10
40226 V0 008	6	1/8	5.4	21	20.5	11	13	12.5	10
40226 V0 009	6	1/4	7.1	21	22	11	16	12.5	10
40226 V0 010	8	1/8	5.4	22.5	22.5	13	13	14.5	10
40226 V0 011	8	1/4	7.1	22.5	23	13	16	14.5	10
40226 V0 012	8	3/8	8.1	22.5	25	13	20	14.5	10
40226 V0 013	8	1/2	9.6	22.5	26.5	13	25	14.5	10
40226 V0 014	10	1/4	7.1	26.5	27.1	14	16	17.5	10
40226 V0 015	10	3/8	8.1	26.5	26.6	14	20	17.5	10
40226 V0 016	10	1/2	9.6	26.5	28.1	14	25	17.5	10
40226 V0 017	12	3/8	8.1	31.5	29.1	16	20	21.5	10
40226 V0 018	12	1/2	9.6	31.5	31.6	16	25	21.5	10

## 40230V

### RACCORDO A T INTERMEDIO

TEE CONNECTOR  
 T-ANSCHLUSS  
 RACCORD TÉ  
 RACOR A T INTERMEDIO  
 CONEXÃO EM "T" TUBO-TUBO

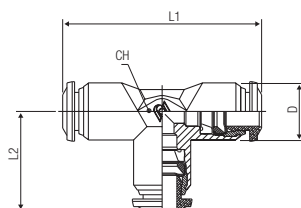

Code	Tube	L1	L2	CH	D	Pack.
40230 V0 001	4 (5/32)	34	17	9	10	10
40230 V0 002	6	42	21	11	12.5	10
40230 V0 003	8 (5/16)	45	22.5	13	14	10
40230 V0 004	10	53	26.5	16	17	10
40230 V0 005	12	61	30.5	19	21.5	10
40230 V0 008	14	65.5	32.5	19	21.5	10

## 40310V

### RACCORDO A Y INTERMEDIO

Y CONNECTOR

Y-ANSCHLUSS

RACCORD Y SIMPLE

RACOR A Y INTERMEDIO

CONEXÃO EM "Y" TUBO-TUBO

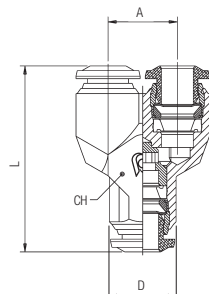

Code	Tube	A	L	CH	D	Pack.
40310 V0 001	4 (5/32)	11	32	11	10	10
40310 V0 002	6	13.5	36.5	13	12.5	10
40310 V0 003	8 (5/16)	15.5	41	15	14	10
40310 V0 008	10	18.5	48	18	17	10

## 40550V

### RACCORDO A L ORIENTABILE MASCHIO CILINDRICO

ORIENTING SINGLE BANJO BODY MALE

WINKELVERSCHRAUBUNG ZYLINDRISCH (DREHBAR)

EQUERRE ORIENTABLE MÂLE, CYLINDRIQUE

RACOR A L ORIENTABLE MACHO CILÍNDRICO CON TÓRICA

CONEXÃO MACHO EM "L" ORIENTÁVEL COM ROSCA PARALELA

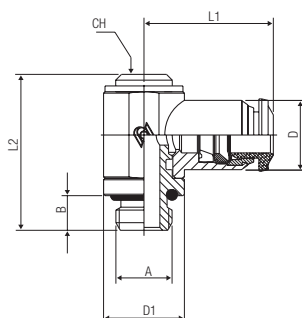

Code	Tube	A	B	L1	L2	CH	D1	D	Pack.
40550 V0 001	4	M5	3.6	19	24.5	-	9	10	10
40550 V0 002	4	1/8	5.4	21	28	5	14	10	10
40550 V0 015	6	M5	3.6	20.5	24.5	-	9	12.5	10
40550 V0 003	6	1/8	5.4	22.5	28	5	14	12.5	10
40550 V0 004	6	1/4	7.1	25	31	6	18	12.5	10
40550 V0 005	8	1/8	5.4	24	28	5	14	14	10
40550 V0 006	8	1/4	7.1	26	31	6	18	14	10
40550 V0 007	8	3/8	8.1	28	35.5	7	21	14	10
40550 V0 008	10	1/4	7.1	29	31	6	18	17	10
40550 V0 009	10	3/8	8.1	30.5	35.5	7	21	17	10
40550 V0 011	12	3/8	8.1	32.5	35.5	7	21	21.5	10

## 50600V

### ADATTATORE MASCHIO CILINDRICO

MALE ADAPTOR PARALLEL

EINSCHRAUBSTECKVERSCHRAUBUNG ZYLINDRISCH

ADAPTATEUR ENLIQUETABLE MÂLE, CYLINDRIQUE

ADAPTADOR MACHO CILÍNDRICO CON TÓRICA

ADAPTADOR MACHO COM ROSCA PARALELA

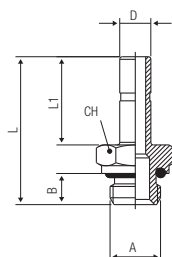

Code	D	A	B	L	L1	CH	Pack.
50600 V0 001	4	M5	3.6	24	15	8	10
50600 V0 002	4	1/8	5.4	26.5	15	13	10
50600 V0 015	6	M5	3.6	26	17	8	10
50600 V0 003	6	1/8	5.4	28.5	17	13	10
50600 V0 004	6	1/4	7.1	31	17	16	10
50600 V0 005	8	1/8	5.4	29.5	18	13	10
50600 V0 006	8	1/4	7.1	32	18	16	10
50600 V0 007	8	3/8	8.1	33.5	18	20	10
50600 V0 016	10	1/8	5.4	33.5	22	13	10
50600 V0 008	10	1/4	7.1	36	22	16	10
50600 V0 009	10	3/8	8.1	37.5	22	20	10
50600 V0 010	12	1/4	7.1	38.5	24.5	16	10
50600 V0 011	12	3/8	8.1	40	24.5	20	10
50600 V0 018	14	1/2	9.6	44	26.5	24	10

## CH028

### ADATTATORE MASCHIO CON ATTACCO PORTAGOMMA

MALE HOSE ADAPTER  
 EINSTECK-SCHLAUCHTÜLLE  
 DOUILLE CANNELEE ENCLIQUETABLE POUR TUYAU  
 ADAPTADOR MACHO CON ESPIGA  
 ADAPTADOR MACHO COM ESPIGÃO

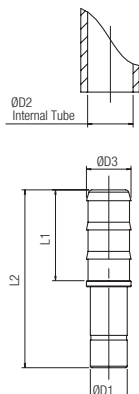

Code	D1	D3	D2	L1	L2	Pack.
CH028 00 01 FS NB	12	10	8	22.5	49	10
CH028 00 01 GP NB	8	10	8	22.5	42.5	10
CH028 00 01 GQ NB	12	14,5	12,5	29,5	56	10
CH028 00 01 WI NB	8	8,3	6,3	22,5	42,5	10
CH028 00 01 Y1 NB	12	12	10	27,5	56	10

## 50625

### GIUNZIONE DOPPIA

DOUBLE JOINT  
 DOPPELSTECKER  
 JONCTION DOUBLE  
 UNIÓN DOBLE  
 JUNÇÃO DUPLA

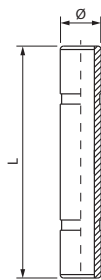

Code	Tube (Ø)	L	Pack.
50625 00 01 X1 NB	4	31	10
50625 00 01 X4 NB	6	34	10
50625 00 01 X7 NB	8	36	10
50625 00 01 X9 NB	10	45	10
50625 00 01 Y1 NB	12	50	10

## 40700V

### RIDUZIONE

REDUCER  
 REDUZIERUNG  
 RÉDUCTION ENCLIQUETABLE  
 REDUCCION  
 REDUÇÃO

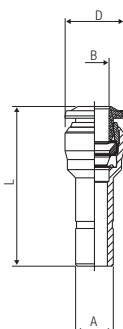

Code	A	B	L	D	Pack.
40700 V0 001	6	4	29.5	10.5	10
40700 V0 008	8	4	32	10.5	10
40700 V0 002	8	6	34	12.5	10
40700 V0 009	10	4	31	10.5	10
40700 V0 003	10	8	38	14.5	10
40700 V0 007	12	8	39	14.5	10
40700 V0 010	12	10	43	17.5	10

## 57610

**TAPPO**

PLUG  
 VERSCHLUSSZAPFEN  
 BOUCHON ENCLIQUETABLE  
 TAPÓN  
 TAMPÃO

Code	D	G	L	L1	Pack.
57610 00 01 X1 NB	4	8	25.5	18.5	10
57610 00 01 X4 NB	6	8	27.5	20.5	10
57610 00 01 X7 NB	8	12	29.5	21.5	10
57610 00 01 X9 NB	10	12	32.5	24.5	10
57610 00 01 Y1 NB	12	16	36.5	27.5	10
57610 00 01 Y3 NB	14	16	35.5	26.5	10

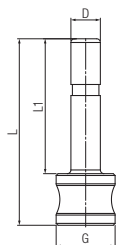

## 50980

**CLIP DI SICUREZZA**

SECURITY CLIPS  
 SICHERHEITSClip  
 CLIP DE SECURITÉ  
 CLIP DE SEGURIDAD ROJO  
 CLIP DE SEGURANÇA

Code	Tube	Pack.
50980 00 32 X1 RO	4-(5/32)	50
50980 00 32 X4 RO	6-(1/4)	50
50980 00 32 X7 RO	8-(5/16)	50
50980 00 32 X9 RO	10-(3/8)	50
50980 00 32 Y1 RO	12-(1/2)	50
50980 00 32 Y3 RO	14	50

